



# OMNIPOINT 30



**Hand-Held  
Meter**

# Operating Manual

YOUR PARTNER IN SENSOR TECHNOLOGY



**ELEKTRONIK<sup>®</sup>**  
Ges.m.b.H.

The operating manual is used to ensure optimal operation and functioning of the device. E+E Elektronik® Ges.m.b.H. provides no warranty of any kind on this publication and no liability for improper use of the products described.

To ensure perfect functioning, these operating instructions must be read carefully and observed before the transmitter is commissioned. These instructions must be provided to all persons responsible for mounting, commissioning, operation, inspection, maintenance and repair.

These operating instructions must not be used for the purposes of competition without our written permission and must not be forwarded to third parties. Copies may be made for internal purposes. All information, technical data and technical diagrams included in these instructions were correct in accordance with the data available at the time of writing.

The company E+E Elektronik GmbH reserves the right to make modifications at any time and without prior notification, with no update requirement on models produced before the modification date. For this reason, we request that you contact our customer service department, quoting the device number, designation and type given on the nameplate.

**© Copyright E+E Elektronik Ges.m.b.H.  
All rights reserved.**

# Inhaltsverzeichnis

<b>1.</b>	<b>NOTES REGARDING THE MANUAL</b>	<b>4</b>
1.1	<i>Preface</i>	4
1.2	<i>Symbols</i>	4
1.3	<i>Definitions</i>	4
<b>2.</b>	<b>INFORMATION ABOUT THE DEVICE</b>	<b>5</b>
2.1	<i>Description of the device</i>	5
2.2	<i>Device depiction</i>	5
2.3	<i>Technical Data</i>	6
2.4	<i>Scope of supply</i>	6
<b>3.</b>	<b>SAFETY</b>	<b>6</b>
3.1	<i>Intended use</i>	6
3.2	<i>Improper use</i>	7
3.3	<i>Personnel qualifications</i>	7
3.4	<i>Residual risks</i>	7
<b>4.</b>	<b>TRANSPORT AND STORAGE</b>	<b>8</b>
4.1	<i>Transport</i>	8
4.2	<i>Storage</i>	8
<b>5.</b>	<b>OPERATION</b>	<b>9</b>
5.1	<i>Inserting the batteries</i>	9
5.2	<i>Switching on</i>	9
5.3	<i>Switching off</i>	9
5.4	<i>Description of screen elements</i>	9
5.5	<i>"Measuring mode – Air pressure" screen (integrated probe)</i>	11
5.6	<i>"Measuring mode – Air pressure – Automatic measurement" screen (integrated probe)</i>	12
5.7	<i>"Customer Adjustment - Air pressure" screen</i>	13
5.8	<i>"Measuring mode - Flow rate" screen</i>	14
5.9	<i>"Measuring mode – Flow rate – Automatic measurement" screen</i>	15
5.10	<i>"Measuring mode – Flowrate – Measuring range" screen</i>	16
5.11	<i>"Customer Adjustment - Flowrate" screen</i>	17
5.12	<i>"Measuring mode – Humidity" screen</i>	18
5.13	<i>"Measuring mode – Humidity – Automatic measurement" screen</i>	19
5.14	<i>"Customer adjustment - Humidity" screen</i>	20
5.15	<i>"Measuring mode – Moisture in oil" screen</i>	21
5.16	<i>"Measuring mode – Moisture in oil – Automatic measurement"</i>	22
5.17	<i>"Oil parameters – Moisture in oil" screen</i>	23
5.18	<i>"Customer adjustment – Moisture in oil" screen</i>	24
5.19	<i>"Measuring mode – CO<sub>2</sub>" screen</i>	25
5.20	<i>"Measuring mode – CO<sub>2</sub> – Automatic measurement" screen</i>	26
5.21	<i>"Customer Adjustment - CO<sub>2</sub>" screen</i>	27
5.22	<i>Explanation of the measured values</i>	28
5.23	<i>"Archive" screen</i>	30
5.24	<i>"Settings" screen</i>	31
5.25	<i>Performing measurement (exemplary using probe for temperature and air flow measuring)</i>	33
5.26	<i>and air flow measuring)</i>	33
5.27	<i>Shut down procedure</i>	33
<b>6.</b>	<b>PC-SOFTWARE</b>	<b>34</b>
6.1	<i>Installation conditions</i>	34
6.2	<i>Installing the PC software</i>	34
6.3	<i>Starting the PC software</i>	34
<b>7.</b>	<b>ERRORS AND FAULTS</b>	<b>35</b>
7.1	<i>Status and error codes</i>	35
<b>8.</b>	<b>MAINTENANCE</b>	<b>35</b>
8.1	<i>Maintenance and care intervals</i>	35
8.2	<i>Activities for before the start of maintenance</i>	36
8.3	<i>Visual inspection of the device</i>	36
8.4	<i>Cleaning the device</i>	36
8.5	<i>Maintenance of humidity probes</i>	36
<b>9.</b>	<b>DISPOSAL</b>	<b>37</b>
<b>10.</b>	<b>DECLARATION OF CONFORMITY</b>	<b>37</b>

# 1. NOTES REGARDING THE MANUAL

## 1.1 Preface

The operating manual only describes the multifunctional hand-held and its intended use. Detailed descriptions of the sensors and optional accessories as well as tips for proper and practical use of the multifunctional hand-held are not included in this manual.

The current version of the manual and the general catalogue can be found at:  
[www.epluse.com](http://www.epluse.com)

## 1.2 Symbols



### **Hazardous electric current!**

Warns about hazards from electric current which can lead to injuries or even death.



### **Danger!**

Warns of a hazard which can lead to personal injury.



### **Caution!**

Warns of a hazard which can lead to damage to property.

## 1.3 Definitions

<b>Concept</b>	<b>Meaning</b>
SDI connection	Serial Digital Interface; digital serial interface for connecting sensors
SmartGraph3	PC software for analysis and visualisation of measured values

## 2. INFORMATION ABOUT THE DEVICE

### 2.1 Description of the device

The multifunctional hand-held Omniport 30 is used for carrying out accurate measured value detection. Several probes can be connected to the digital interface of the device for this purpose.

The operating elements are found on the front and sides of the robust housing. A scratch proof colour display with touch function (1) allows entering and selecting values and functions and also displaying detected results. You can also navigate the device software by using the cross control (3) and the "OK" key (5) and select measuring functions.

By pressing the "Back" key (2) you return to the previous screen of the device software.

Pressing the "Main menu" key (6) directly opens the main menu. Pressing the "Illumination on/off" key (4) either switches the background illumination for the colour display and the keys on or dims them.

Located above the colour display (1) is the connection for the digital probes (7). Here connect the appropriate digital probe corresponding to situation. The universal interface of the digital probes allows the multifunctional hand-held to automatically detect the probe construction, so that after switching the device on the corresponding measuring mode is displayed automatically. If no probe is connected, an error code (see chapter "Status and error codes") is shown on the colour display (1). Depending on the probe type, it is calibrated to the prevailing surrounding conditions after connection. Calculated by the multifunctional hand-held from the various basic measured values, such as temperature and humidity, are the desired derived measured values like dew point temperature, partial vapour pressure etc. The measured results of the connected probe are shown in the device's colour display (1).

The "On/Off" key (9) and a USB connection (10) are found on the sides of the device.

You can connect the device to a computer by using the supplied USB connection cable. Then you can extract and analyse your measured results with the SmartGraph3 software.

### 2.2 Device depiction

No.	Operating element
1	scratch proof colour display with touch function
2	"Back" key
3	cross control with "Up", "Down", "Left", "Right" keys
4	"Illumination on/off" key
5	"OK" key
6	"Main menu" key
7	connection for digital sensors (5-pin)
8	battery compartment with battery cover
9	"On/Off" key
10	micro USB connection

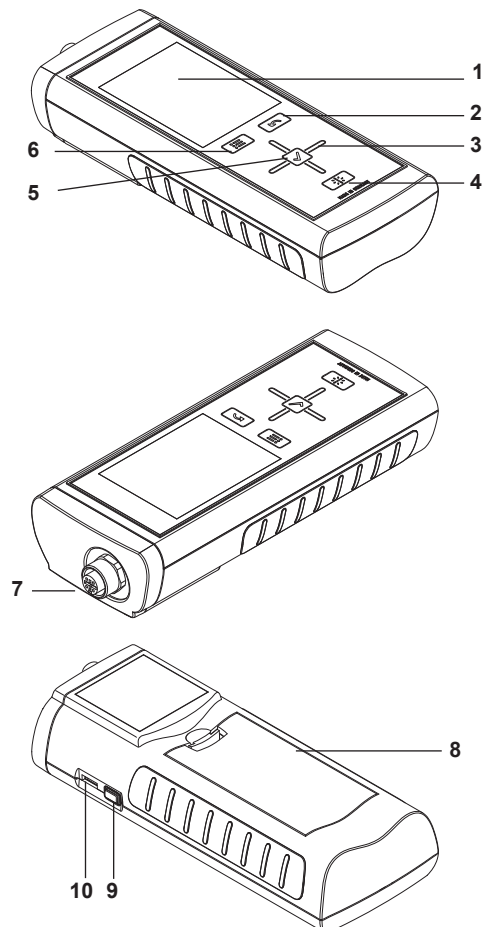

## 2.3 Technical Data

### General

Power supply	4 x Alkaline LR6 AA batteries, 1.5 V
Optional power supply	5V DC via USB (cable included)
Temperature range	operating: handheld and handle of sensing probe: 0...50°C (32...122°F) storage: -20...60°C (-4...140°F)
Internal memory	for approx. 2 million measured values
Housing / protection class	ABS / IP40
Dimensions (HxWxD)	170 x 62 x 34 mm (6.69 x 2.44 x 1.34")
Weight	ca. 205g (0.45 lbs)
Display	TFT display, 54 x 41 mm (2.13 x 1.61"), illuminated
CE compatibility	EN61326-1:2006 EN61326-2-1:2006



### Integrated air pressure sensor

Measuring range	800 to 1100 mbar (complete accuracy)
Accuracy	max. ± 0.5 mbar (at 25 °C, 1013.25 mbar)
Long term stability	typ. -1 mbar/year

## 2.4 Scope of supply

Scope of delivery includes:

- 1 x Multifunctional Hand-held
- 1 x USB connection cable
- 4 x Alkaline LR6 AA, 1.5 V batteries
- 1 x Getting started guide
- 1 x Factory test certificate
  
- 1 x moisture in oil probe with calibration certificate\*
- 1 x carrying case\*
- 1 x operating manual\*
- 1 x calibration device, salt solutions and calibration certificate\*\*

Additionally available free of charge is the SmartGraph3 PC software ([www.epluse.com/smartgraph3](http://www.epluse.com/smartgraph3)) for archiving and analysing data.

## 3. SAFETY

**Carefully read the operating manual before using the device and keep it within reach!**

- Do not use the device in atmospheres containing sulphur, chlorine or salt.
- Ensure that all connection cables are protected from damage (e.g. from kinks or crushing).
- Protect the device from permanent direct sunlight.
- Observe the storage and operating conditions (see chapter "Technical data").

### 3.1 Intended use

Use the multifunctional hand-held Omniport 30 only in the field of climate diagnostics, while adhering to and following the technical data. To use the device for its intended use, only connect and use accessories and spare parts which have been approved by E+E Elektronik.

**Intended use encapsulates e.g.**

- the analyses of
  - supply and exhaust air flows,
  - fluctuations in relative humidity,
  - condensate formation,
  - heat build-ups and temperature fluctuations,
  - moisture in oil measurement and
- the utilization as reference device according to DIN EN ISO 9001.

\*) only for OILPORT SET

\*\*) only for OILPORT SET with option C01

### 3.2 Improper use

Do not use the device in potentially explosive atmospheres, or for measurements in liquids (except oil). E+E Elektronik accepts no liability for damage resulting from improper use. In such a case, entitlements to a warranty are forfeited. Any unauthorised modifications, alterations or structural changes to the device are forbidden.

### 3.3 Personnel qualifications

People who use this device must:

- know and understand the dangers of working near live parts.
- take measures to protect themselves from direct contact with live parts.
- have read and understood the operating manual, especially the "Safety" chapter.

**For maintenance or repair work which requires the housing to be opened, contact E+E customer service. Devices which have been opened unlawfully are void of any warranty and warranty claims**

### 3.4 Residual risks



#### **Hazardous electric current!**

Work on the electrical components must only be carried out by an authorised specialist company.



#### **Hazardous electric current!**

Never measure live parts.



#### **Danger!**

Do not leave the packaging lying around. Children may use it as a dangerous toy.



#### **Danger!**

Dangers can occur at the device when it is used by untrained people in an unprofessional or improper way. Observe the personnel qualifications.



#### **Caution!**

To prevent damage to the device, do not expose it to extreme temperatures, extreme humidity or moisture.



#### **Caution!**

To prevent damage to the device or to a connected probe due to overheating, observe the permissible operating and measuring ranges of the device and the connected probe. The corresponding specifications are provided in the general catalogue for industrial measuring devices or on [www.epluse.com](http://www.epluse.com) under the "Information material – Industrial measuring devices" menu.

## 4. TRANSPORT AND STORAGE

### 4.1 Transport

To safely transport the multifunctional hand-held and accessories, use the recommended carrying case (11). The carrying case is equipped with special compartments where the multifunctional hand-held and accessories can be kept. Otherwise, protect the device during use and transport with an optional protective cover (12).

No.	Operating element
11	Carrying case
12	Protective cover
13	OMNIPORT 30
14	CO2 probe
15	Miniature humidity probe
16	Humidity or flow probe with handle
17	Humidity or flow probe with handle
18	Calibration device
19	2x calibration solution
20	Cables and accessories

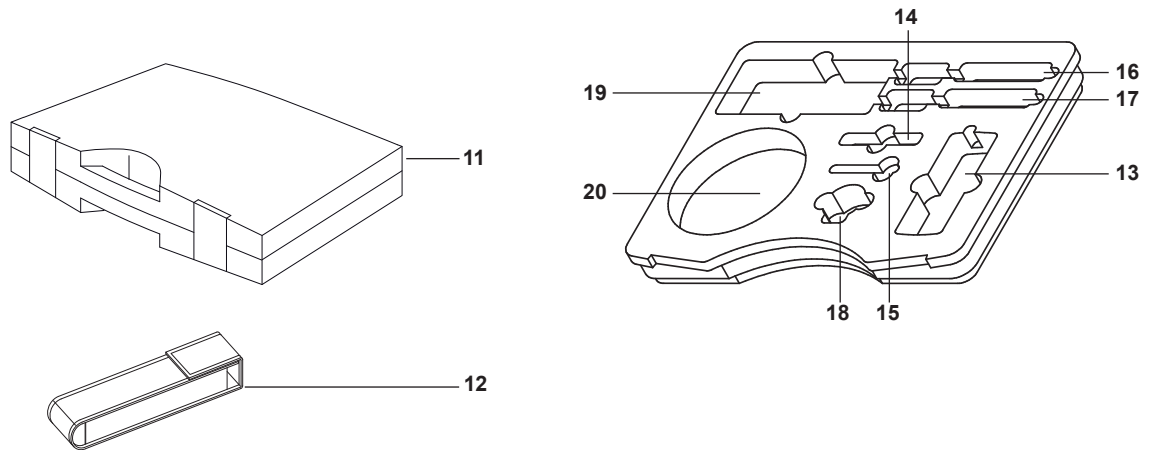

### 4.2 Storage

When the device is not being used, observe the following storage conditions:

- dry, protected from dust and direct sunlight,
- with a plastic cover to protect it from invasive dust, if necessary.
- The storage temperature is the same as the range given in the chapter "Technical data".
- When storing the device for a long time, remove the batteries.
- To store the device, use the carrying case (see chapter "Transport") wherever possible.



## 5. OPERATION

### 5.1 Inserting the batteries

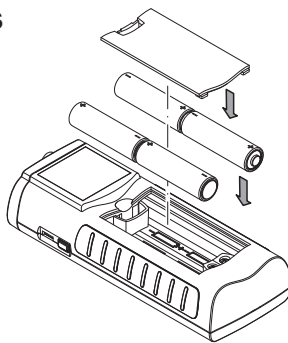

### 5.2 Switching on

1. Press and hold the "On/Off" key for approx.3 seconds until the device beeps.
2. Release the "On/Off" key – The colour display is switched on. The device is ready for operation as soon as the screen of the particular measuring mode is displayed (depends on the connected probe).

### 5.3 Switching off

1. Press and hold the "On/Off" key for approx.3 seconds until the device beeps.
2. Release the "On/Off" key – The colour display is switched off.

### 5.4 Description of screen elements

When using the device, take special note of the following important operating elements and displays:

- The "Back" key (2) opens the previous menu.

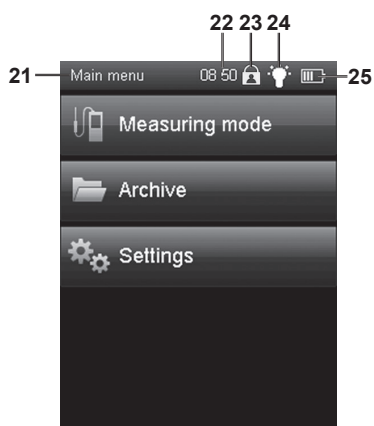

- The "Main menu" key (6) opens the main menu.
- Name of the current screen (21)
- Display of the current time (22)
- The "Padlock" symbol (23) appears when you press and hold the "On/Off" key for approx. 1 second during a measurement. The touch function of the colour display is locked. To release the lock, press and hold the "On/Off" key for approx. 1 second.
- The "Lightbulb" symbol (24) appears when you have used the "Illumination on/off" key to switch on background illumination (see chapter "Information about the device").
- Battery loading status indicator (25); a plug symbol is shown when power is supplied via a USB connection.



All options which can be selected via touch function can also be selected by using the cross control and the "OK" key. For safety reasons, some options can only be selected and configured by using the cross control and the "OK" key (e.g. date and time in the "Settings" screen).

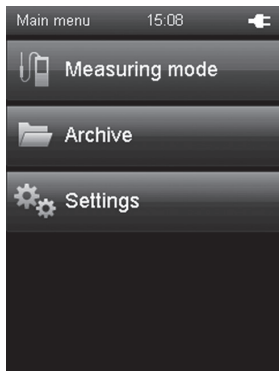
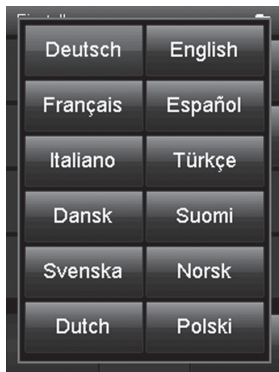
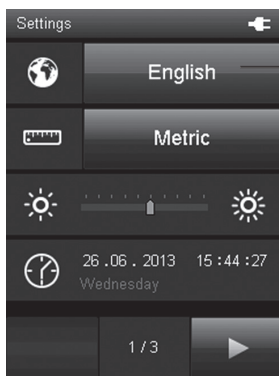

## Set language

1. Press the "Main menu" key (6) to open the main menu.
2. Press the "Settings" key in the main menu.

3. Press the language selection key (26) in the "Settings" screen.

4. Press the key with the desired language from the following screen.– The selected screen language is activated immediately.

5. Press the "Back" key (2) to return to the desired measuring mode. Alternatively press the "Main menu" key and then the "Measuring mode" key.

## Main menu

You can open the following menus from the main menu:

### *Measuring mode:*

Perform measurements in compliance with the connected probe. If no probe is connected, only the values from the integrated air pressure probe are available.

### *Archive:*

Open archived measured values

### *Settings:*

Make any device settings

## 5.5 "Measuring mode – Air pressure" screen (integrated probe)

### Note!

This measuring mode is only displayed when no digital probe is connected.

A.

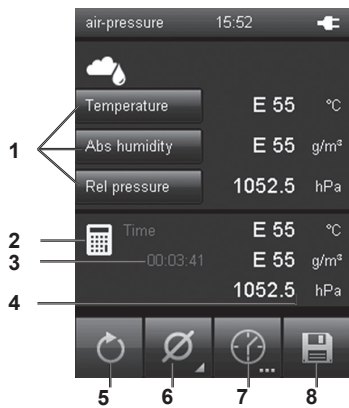

B.



C.

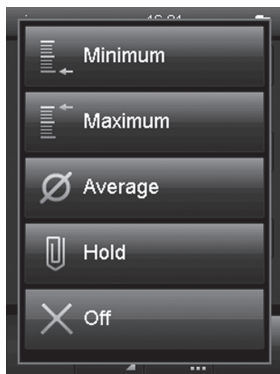

- 1 When using the integrated air pressure sensor, only select the measured values for air pressure (see fig. B.). The latest measured value is displayed next to the corresponding key on the right (also see chapter "Explanation of the measured values", page 28). The remaining selection options are disabled/greyed out. Should you select one of the disabled entries, "E55" is displayed. If applicable, deactivate the display by pressing one of the keys marked (1) and selecting "Off" at the end of the list in the pop-up window (see fig. B.).
- 2 This symbol indicates, that the displayed measured values under (4) are calculated (e.g. minimum/maximum measured value).
- 3 Indicates the measurement duration.
- 4 Displays the calculated measured values according to the specifications under (1) and (6). The calculation starts when switching the multifunctional hand-held on. Actuating key (5) restarts the calculation of measured values.
- 5 Sets the measured values displayed under (4) and the duration shown under (3) back to zero.
- 6 **Specifies how the measured values under 4 are shown (see fig. C.):**
  - Minimum: Always shows the smallest detected measured value from a measuring period.
  - Maximum: Always shows the largest detected measured value from a measuring period.
  - Average: Shows the average value of all detected measured values from a measuring period.
  - Hold: Pauses the current detected measured value and shows it continually (when this option is selected).
  - Off: Switches off the measured values (4).
- 7 Carries out an automatic measurement for the duration of an already specified recording interval. The recording interval can be specified in the following screen (see fig. D. and fig. E., page 12).
- 8 Saves the currently displayed measured value as single measurement in the archive with date and time stamp.
- 9 Opens the customer adjustment menu.

## 5.6 "Measuring mode – Air pressure – Automatic measurement" screen (integrated probe)

D.

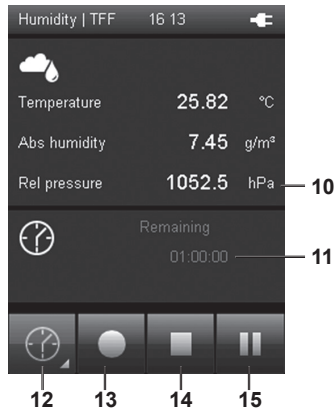

10 hPa: Displays the measured value according to the specifications under (1) (e.g. in the measuring unit hectopascal) (see fig. A., page 11).

11 Indicates the remaining recording duration for the automatic measurement.

12 Opens a screen for selecting the recording duration for measuring over a long period (see fig. E.).

13 Starts recording. The key turns red once recording has started.

### Note!

During an active recording it is not possible to switch off the multifunctional hand-held with the "On/Off" key. Automatic switch-off is also deactivated. First stop the recording by pressing key (13) and then turn off the device.

E.

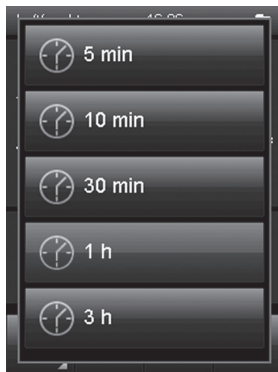

14 Stops the current recording. The detected values are automatically saved to the current measuring project.

15 Pauses the current recording. Key (12) flashes. Press key (14) again to continue recording.

## 5.7 "Customer Adjustment - Air pressure" screen

F.



In measurement mode press button (1) in fig. F and select one of the calculation modes shown in fig. C.

The CAL button will appear in the top right corner (only if adjustment is possible for the selected measurand).

G.



**Adjustment is always performed for the measurand in the top box !**

In air pressure mode adjustment is only possible for measurands in hPa.

Press button CAL (2) in fig. G. to open the customer adjustment mode.

H.

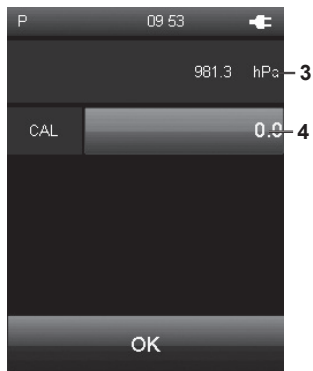

For air pressure measurement a 1-point adjustment is available

Select the value field (4) in fig. H to adjust the current measured value (3).

I.



Using the keypad in fig. I, enter the deviation of the current measured value (3) from the reference value.

Press OK (5) to confirm and return to measurement mode.

Set the deviance to 0.00 to restore **factory settings**.

## 5.8 "Measuring mode - Flow rate" screen

A.

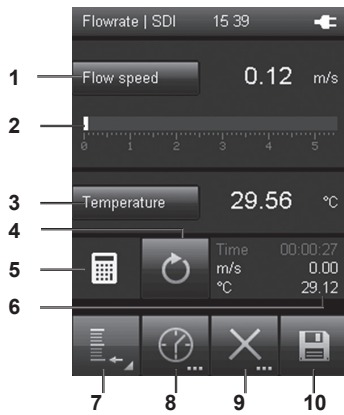

B.

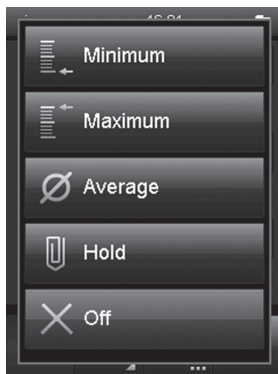

- 1 Shows the measured flow rate as a numerical value in the selected unit (e.g. m/s).  
In order to display and select the available units, touch "Flow speed" (see chapter "Explanation of the measured values", page 28).
- 2 Shows the measured flow rate as visual bars.
- 3 In order to display and select the available measured values, touch "Temperature" (see chapter "Explanation of the measured values", page 28).  
Select "Off" to switch the display off.
- 4 Sets the measured values displayed under (6) and the duration back to zero
- 5 This symbol indicates, that the displayed measured values under (7) are calculated (e.g. minimum/maximum measured value).
- 6 Displays the calculated measured values according to the specifications under (1), (3) and (7):  
Time: Duration of the interval  
m/s: Shows the flow rate as a numerical value in the selected unit (e.g. m/s).  
°C: Displays the temperature value (e.g. in °C).
- 7 Specifies how the measured values under (6) are shown (see fig. B.):  
Minimum: Always shows the smallest detected measured value from a measuring period.  
Maximum: Always shows the largest detected measured value from a measuring period.  
Average: Shows the average value of all measured values which have been detected so far from a measuring period.  
Hold: Pauses the current detected measured value and shows it continually (when this option is selected).  
Off: Switches (6) display off.
- 8 Carries out an automatic measurement for the duration of an already specified recording interval. The recording interval can be specified in the following screen (see fig. C. and fig. D., page 15).
- 9 Opens fig. E., page 16, where you can specify parameters for the volumetric flow measurement (e.g. the form of the object to be measured).
- 10 Saves the currently displayed measured value as single measurement in the archive with date and time stamp.

## 5.9 "Measuring mode – Flow rate – Automatic measurement" screen

C.

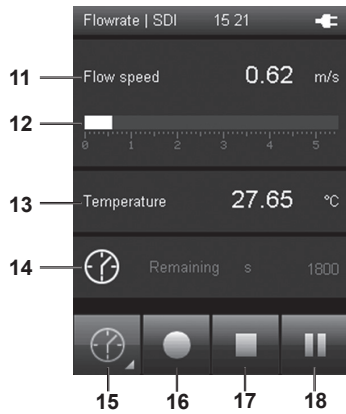

11

12

13

14

15

16

17

18

11 Shows the measured flow rate as a numerical value in the selected unit (e.g. m/s).

You can select the unit under (1) in fig. A., page 14.

12 Shows the measured flow rate as visual bars.

**Note!**

This display is only available when measuring flow values. The representations in fig. C. can slightly deviate depending on the previous setting.

13 Shows the measured temperature value.

14 Shows the remaining time until the automatic measurement finishes.

15 Opens a screen for selecting the recording duration (see fig. D.).

16 Starts recording.

The key turns red once recording has started.

**Note!**

During an active recording it is not possible to switch off the multifunctional hand-held with the "On/Off" key. Automatic switch-off is also deactivated. First stop the recording by pressing key (17) and then turn off the device.

17 Stops the current recording. The detected values are automatically saved to the current measuring project.

18 Pauses the current recording. Key (16) flashes.

Press the key (18) again to continue recording.

D.

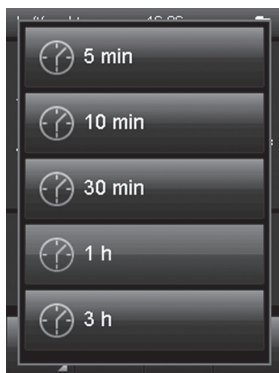

## 5.10 "Measuring mode – Flowrate – Measuring range" screen

E.

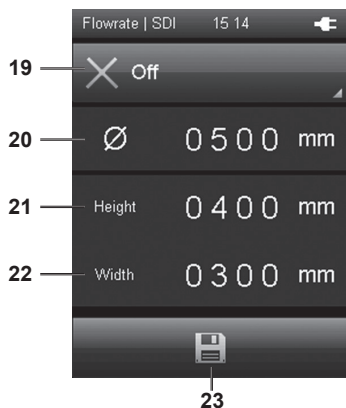

19 Selects the form of the object to be measured. The following options are available (see fig. F.)::

1. Square (volumetric flow measurement)
2. Round (volumetric flow measurement)
3. Off (no volumetric flow measurement)

Depending on the selected form, a different equation is used to calculate the measured values. The measured values displayed under (1) or (3) in fig. A., page 14 depend on the settings selected here.

20 Determines the diameter of the object to be measured (with selection "Round" under (19)).

21 Determines the height of the object to be measured (with selection "Square" under (19)).

22 Determines the width of the object to be measured (with-selection "Square" under (19)).

23 Saves the settings and returns to fig. A., page 14.

F.

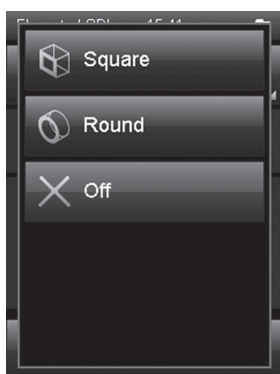

The measured values for the volumetric flow can only be displayed under (1) in fig. A., page 14.

During volumetric flow measurement, further measured values, such as the flow rate, can be displayed under (3) in fig. A., page 14.

### Note!

The settings saved here are also used for all following measurements, unless they are deactivated (in the corresponding menu item)



## 5.11 "Customer Adjustment - Flowrate" screen

G.

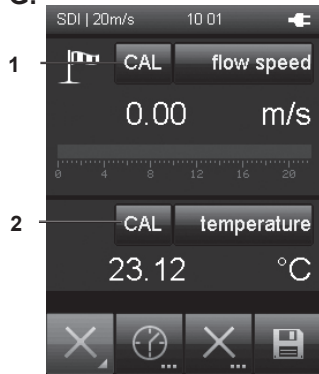

In measurement mode press button CAL (1) or (2) in order to switch to customer adjustment mode (fig. G).

Button (1) opens flow speed adjustment (fig. H) and button (2) opens temperature adjustment (fig. I).

H.

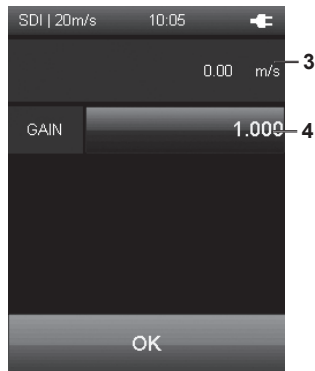

Select the value field (4) in either fig. H or fig. I to adjust the current measured value (3).

I.

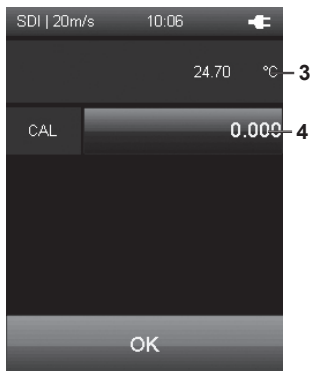

J.

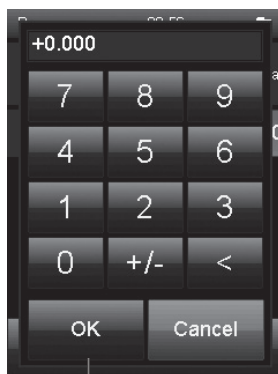

Using the keypad in fig. J, enter the deviation of the current measured value (3) from the reference value.

Press OK (5) to confirm and return to measurement mode.

Set the deviance to 0.00 to restore **factory settings**.

## 5.12 "Measuring mode – Humidity" screen

A.

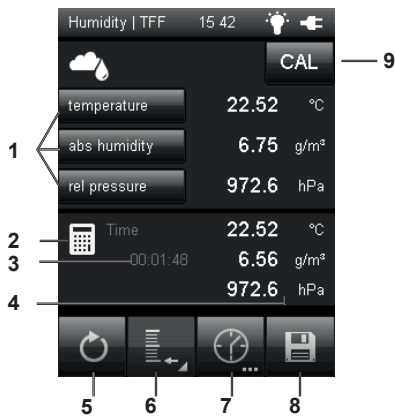

- 1 Specifies how measured values and the corresponding units are shown (see chapter "Explanation of the measured values", page 28). The latest measured value is displayed next to the corresponding key on the right. Select "Off" to switch the respective display off.
- 2 This symbol indicates, that the displayed measured values under (4) are calculated (e.g. minimum/maximum measured value).
- 3 Indicates the measurement duration.
- 4 Displays the measured values according to the specifications under (1) and (6):
  - °C: Displays the temperature according to the specifications under (1) (e.g. in degrees Celsius) and under (6) (e.g. as average value).
  - g/m<sup>3</sup>: Displays the humidity according to the specifications under (1) (e.g. in gram per cubic metre) and under (6) (e.g. as average value).
  - hPa: Displays the air pressure according to the specifications under (1) (e.g. in the measuring unit hectopascal) and under (6) (e.g. as average value).

B.

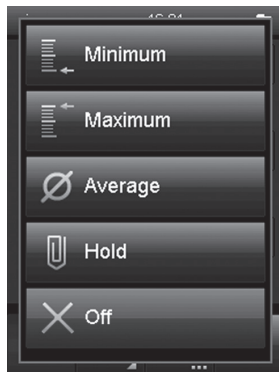

- 5 Sets the measured values shown under (4) back to zero.
- 6 Specifies how the measured values under (4) are shown (see fig. B.):
  - Minimum: Always shows the smallest detected measured value from a measuring period.
  - Maximum: Always shows the largest detected measured value from a measuring period.
  - Average: Shows the average value of all detected measured values from a measuring period.
  - Hold: Pauses the current detected measured value and shows it continually (when this option is selected).
  - Off: Switches off the measured values (4).
- 7 Carries out an automatic measurement for the duration of an already specified recording interval. The recording interval can be specified in the following screen (see fig. C. and fig. D., page 19).
- 8 Saves the currently displayed measured value as single measurement in the archive with date and time stamp.
- 9 Opens the customer adjustment screen.

## 5.13 "Measuring mode – Humidity – Automatic measurement" screen

C.

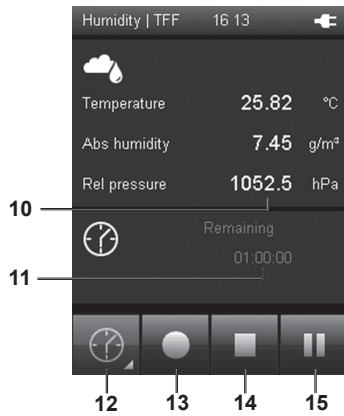

D.



- 10 Displays the measured values according to the specifications under (1) in fig. A.:
- °C: Displays the temperature according to the specifications under (1) (e.g. in degrees Cel-sius)
  - g/m<sup>3</sup>: Displays the humidity according to the specifications under (1) (e.g. in gram per cubic metre).
  - hPa: Displays the air pressure according to the specifications under (1) (e.g. in the measuring unit hectopascal)
- 11 Indicates the remaining recording duration for the automatic measurement.
- 12 Opens a screen for selecting the recording duration for measuring over a long period (see fig. D.).
- 13 Starts recording.  
The key turns red once recording has started.
- Note!**  
During an active recording it is not possible to switch off the multifunctional hand-held with the "On/Off" key. Automatic switch-off is also deactivated. First stop the recording by pressing key (14) and then turn off the device.
- 14 Stops the current recording. The detected values are automatically saved to the current measuring project.
- 15 Pauses the current recording. Key (13) flashes. Press key (15) again to continue recording.

## 5.14 "Customer adjustment - Humidity" screen

E.

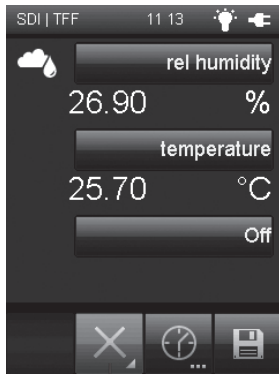

In measurement mode press button (1) in fig. E and select one of the calculation modes shown in fig. B.

The CAL button will appear in the top right corner (only if adjustment is possible for the selected measurand).

F.

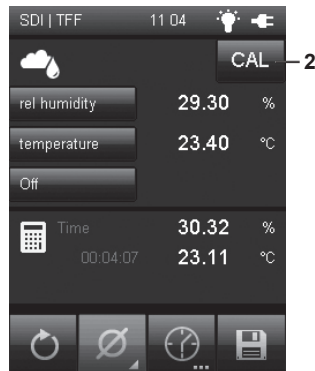

**Adjustment is always performed for the measurand in the top box !**

For rH/T probes an adjustment of humidity and temperature is possible.

Press button CAL (2) in fig F. to open the customer adjustment mode.

G.

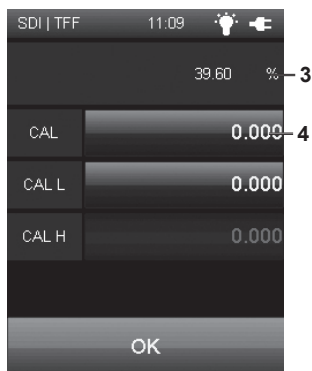

**Customer adjustment of RH/T probes:**

### Temperature

1-point offset or offset/gain adjustment according to probe type.

### Relative Humidity

1-point adjustment: (see fig. J on page 24)

**CAL** - the reference value must be in the range 40...60 % RH.

2-point adjustment: (see fig. K on page 24).

**CAL L** - the reference value low must be in the range 0...40% RH.

**CAL H** - the reference value high must be in the range 60...95% RH.

Offset/Gain adjustment:

Set the linear offset and/or gain of the sensor curve.

H.

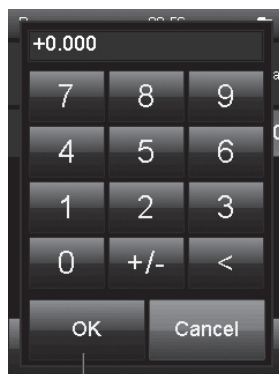

Using the keypad in fig. H, enter the deviation of the current measured value (3) from the reference value.

Press OK (5) to confirm and return to measurement mode.

Set the deviance to 0.00 to restore **factory settings**.

## 5.15 "Measuring mode – Moisture in oil" screen

A.

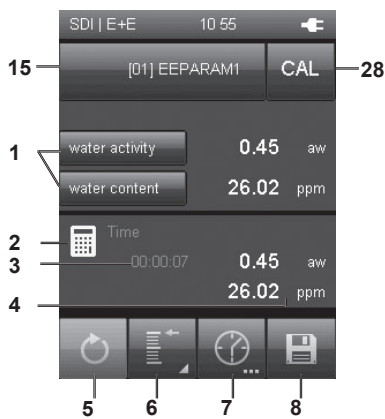

- 1 Specifies how measured values and the corresponding units are shown (see chapter "Explanation of the measured values", page 28). The latest measured value is displayed next to the corresponding key on the right. Select "Off" to switch the respective display off.
- 2 This symbol indicates, that the displayed measured values under (4) are calculated (e.g. minimum/maximum measured value).
- 3 Indicates the measurement duration.
- 4 Displays the measured values according to the specifications under (1) and (6):
  - aw: Displays the water activity according to the specifications under (1) (unitless) and under (6) (e.g. as average value).
  - ppm: Displays the water content according to the specifications under (1) (in ppm) and under (6) (e.g. as average value).

5 Sets the measured values shown under (4) back to zero.

6 Specifies how the measured values under (4) are shown (see fig. B.):

- Minimum: Always shows the smallest detected measured value from a measuring period.
- Maximum: Always shows the largest detected measured value from a measuring period.
- Average: Shows the average value of all detected measured values from a measuring period.
- Hold: Pauses the current detected measured value and shows it continually (when this option is selected).
- Off: Switches off the measured values (4).

B.

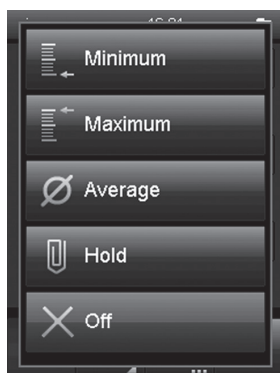

7 Carries out an automatic measurement for the duration of an already specified recording interval. The recording interval can be specified in the following screen (see fig. C. and fig. D., page 22).

8 Saves the currently displayed measured value as single measurement in the archive with date and time stamp.

## 5.16 "Measuring mode – Moisture in oil – Automatic measurement"

C.

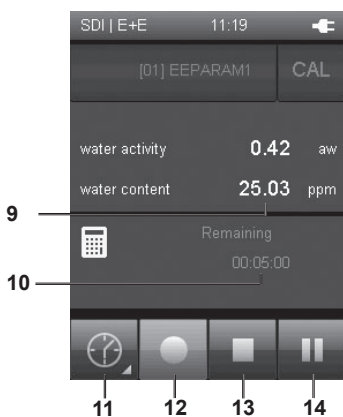

- 9 Displays the measured values according to the specifications under (1) in fig. A.:
  - aw: Displays the water activity according to the specifications under (1) (unitless).
  - ppm: Displays the water content according to the specifications under (1) (in ppm).
- 10 Indicates the remaining recording duration for the automatic measurement.
- 11 Opens a screen for selecting the recording duration for measuring over a long period (see fig. D.).
- 12 Starts recording.  
The key turns red once recording has started.

### Note!

During an active recording it is not possible to switch off the multifunctional hand-held with the "On/Off" key. Automatic switch-off is also deactivated. First stop the recording by pressing key (13) and then turn off the device.

D.

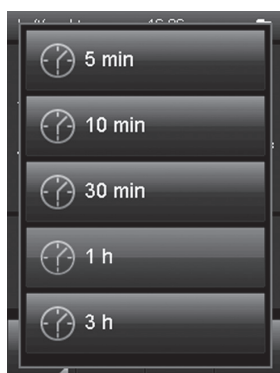

- 13 Stops the current recording. The detected values are automatically saved to the current measuring project.
- 14 Pauses the current recording. Key (12) flashes.  
Press key (14) again to continue recording.

## 5.17 "Oil parameters – Moisture in oil" screen

A.

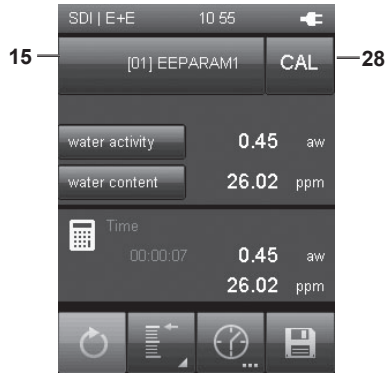

The measurand "water content [ppm]" is a calculated value. For this calculation oil specific parameters (A und B) are needed. The default factory parameter set is [01] EEPARAM1, which contains oil specific parameters for mineral transformer oil. The determination of other oil-specific parameters can be performed by E+E on request.

15 Opens a screen for oil parameter selection (see fig. E). The navigation is partially possible only by using the control cross!

16 Oil parameter set - [01] EEPARAM1 is the default factory setting.

17 Add new oil parameter ser (see fig. G)

18 List of saved oil parameter sets. A maximum of 10 entries is possible.

19 Select a parameter set (see fig. F).

20 Sends and saves the selected parameter set (under 19) in the measuring probe.

21 Edit parameter set (see fig. G).

22 Delete parameter set.

23 Cancel action.

24 Enter name for oil parameter set. Navigate via control cross.

25 Enter A-Parameter (-1999.9...100.0)

26 Enter B-Parameter (0.00..20.00)

27 Confirm and save oil parameters.

28 Opens screen for customer adjustment of the moisture in oil probe (see fig. H).

E.

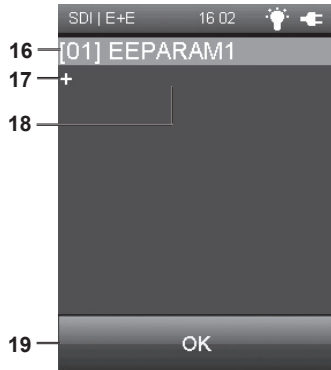

F.



G.

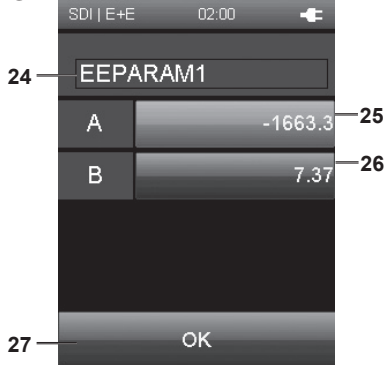

## 5.18 "Customer adjustment – Moisture in oil" screen

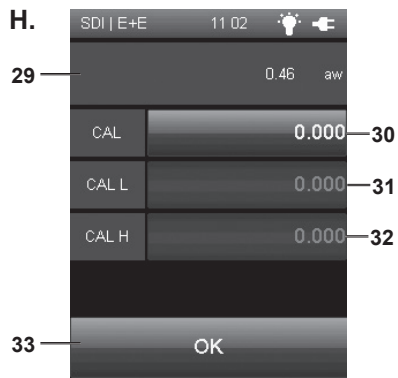

29 Current measured value reading.

### Note!

The customer adjustment is always performed for the measurand in the top box (see fig. A).

30 1-point adjustment: to enter deviation from reference value select field CAL (30).

31 2-point adjustment: to enter deviation from reference value low select field CAL L (31).

32 2-point adjustment: to enter deviation from reference value high select field CAL H (32).

33 Save and exit.

### Customer adjustment for:

#### Temperature:

1-point offset adjustment (see fig. I)

#### Water activity aw:

1-point adjustment: rotation around zero (see fig. J).

**CAL** - the reference value must be in the range 0.40...0.60 aw (29).

2-point adjustment: (see fig. K).

**CAL L** - the reference value low must be in the range 0...0.40 aw (29).

**CAL H** - the reference value high must be in the range 0.60...0.95 aw (29).

**Water content ppm:** no adjustment possible.

Set the deviance to 0.00 to restore **factory settings**.

I.

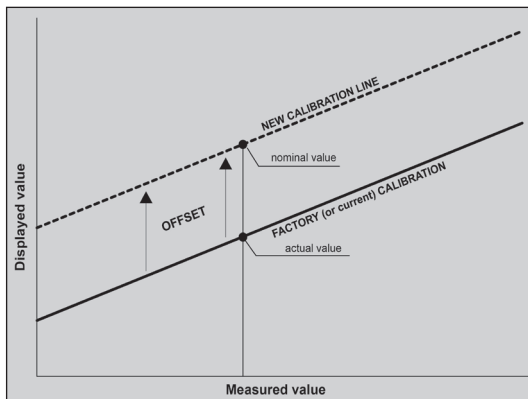

J.

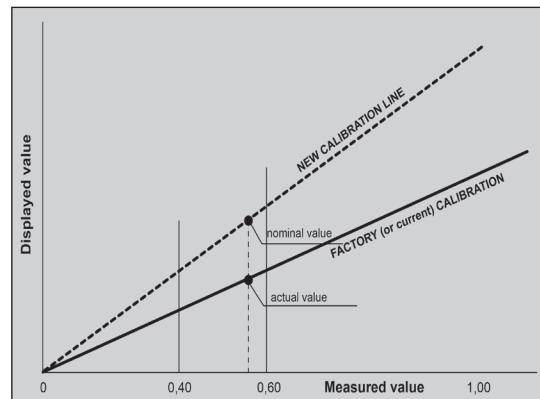

K.

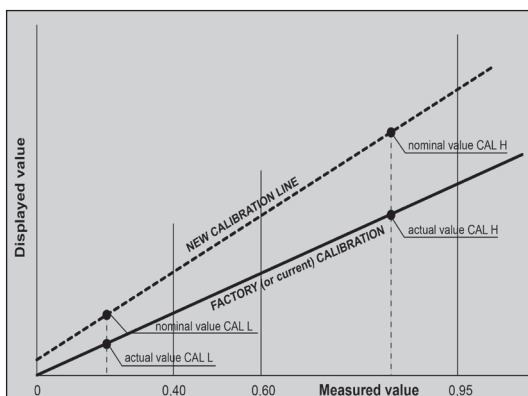



## 5.19 "Measuring mode – CO<sub>2</sub>" screen

A.

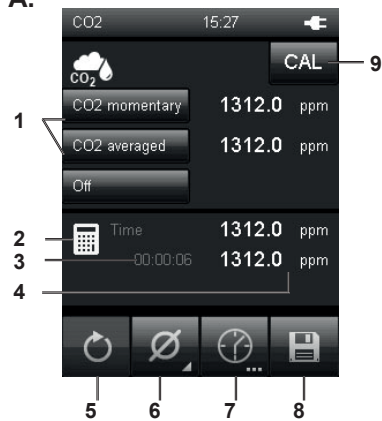

- 1 Specifies how measured values and the corresponding units are shown (see chapter "Explanation of the measured values", page 28). The latest measured value is displayed next to the corresponding key on the right. Select "Off" to switch the respective display off.
- 2 This symbol indicates, that the displayed measured values under (4) are calculated (e.g. minimum/maximum measured value).
- 3 Indicates the measurement duration.
- 4 Displays the measured values according to the specifications under (1) and (6):  
ppm: Displays the temperature according to the specifications under (1) (e.g. in parts per million) and under (6) (e.g. as average value).

5 Sets the measured values shown under (4) back to zero.

- 6 Specifies how the measured values under (4) are shown (see fig. B.):

Minimum: Always shows the smallest detected measured value from a measuring period.

Maximum: Always shows the largest detected measured value from a measuring period.

Average: Shows the average value of all detected measured values from a measuring period

Hold: Pauses the current detected measured value and shows it continually (when this option is selected).

Off: Switches off the measured values (4).

- 7 Carries out an automatic measurement for the duration of an already specified recording interval. The recording interval can be specified in the following screen (see fig. C. and fig. D.).

- 8 Saves the currently displayed measured value as single measurement in the archive with date and time stamp.

- 9 Opens the customer adjustment screen.

B.

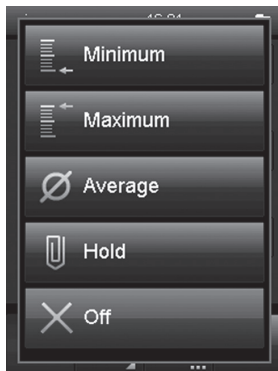

## 5.20 "Measuring mode – CO<sub>2</sub> – Automatic measurement" screen

C.

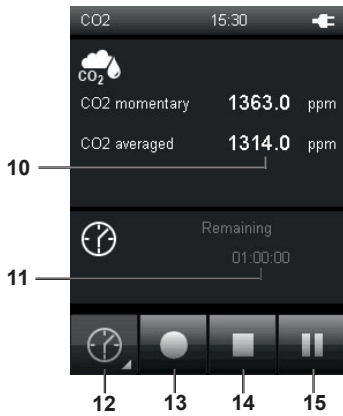

D.

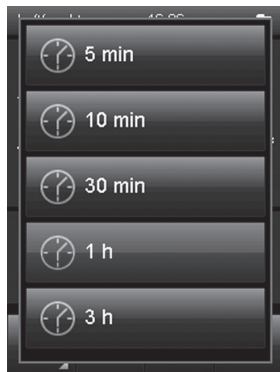

- 10 Displays the measured values according to the specifications under (1) in fig. A.:  
ppm: Displays the CO<sub>2</sub> concentration according to the specifications under (1) (e.g. in parts per million).
- 11 Indicates the remaining recording duration for the automatic measurement.
- 12 Opens a screen for selecting the recording duration for measuring over a long period (see fig. D.).
- 13 Starts recording.  
The key turns red once recording has started.  
**Note!**  
During an active recording it is not possible to switch off the multifunctional hand-held with the "On/Off" key. Automatic switch-off is also deactivated. First stop the recording by pressing key (14) and then turn off the device.
- 14 Stops the current recording. The detected values are automatically saved to the current measuring project.
- 15 Pauses the current recording. Key (13) flashes. Press key (13) again to continue recording.

## 5.21 "Customer Adjustment - CO<sub>2</sub>" screen

E.

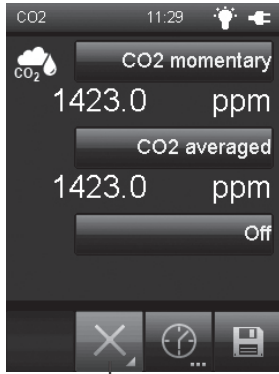

In measurement mode press button (1) in fig. E and select one of the calculation modes shown in fig. B.

The CAL button will appear in the top right corner (only if adjustment is possible for the selected measurand).

F.

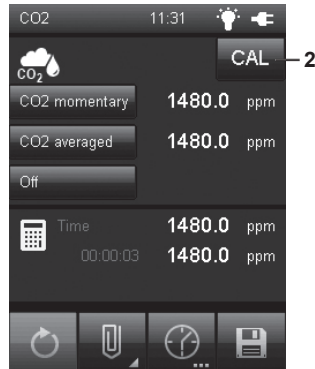

**Adjustment is always performed for the measurand in the top box !**

In CO<sub>2</sub> mode adjustment is only possible for the measurand "CO<sub>2</sub> momentary". The averaged value cannot be adjusted.

Press button CAL (2) in fig. F to open the customer adjustment mode.

G.

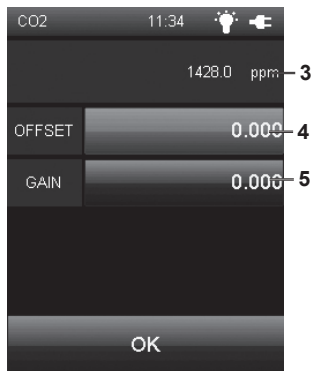

For CO<sub>2</sub> probes an offset / gain adjustment is possible.

Select the value field (4) or (5) in fig. G to adjust the current measured value (3).

H.

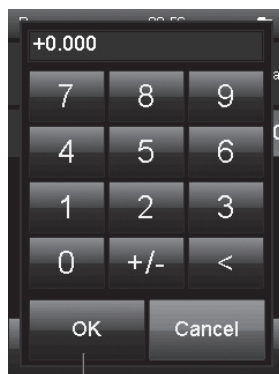

Using the keypad in fig. H, enter the offset (4) and gain(5) deviations.

Press OK (6) to confirm and return to measurement mode.

Set the deviance to 0.00 to restore **factory settings**.

## 5.22 Explanation of the measured values

Depending on the measuring mode and used probe, the following measured values can be selected to be displayed in the corresponding measurement units:

[Unit]	Measured value	Meaning
[g/m <sup>3</sup> ]	Absolute humidity	Indicates the mass of water vapour in relation to the volume, in which the humid gas is contained, in: • grams per cubic metre • grains per cubic foot
[gr/ft <sup>3</sup> ]		
[hPa]	Absolute pressure	Indicates the barometric air pressure. This is the currently present pressure, based on an absolute vacuum of "0" and thus termed absolute pressure. Possible units are: • hectopascal • millimetres of mercury • pounds per square inch
[mmHg]		
[psi]		
[°C]	Ice bulb temperature	Indicates the temperature setting in at the interface of an icy surface and a gas gushing past in: • degrees Celsius • degrees Fahrenheit
[°F]		
[°C]	Wet bulb temperature	Indicates the temperature setting in at the interface of a wet surface and a gas gushing past in: • degrees Celsius • degrees Fahrenheit
[°F]		
[°C]	Frostpoint temperature	Indicates the temperature setting in during icing when the current partial water vapour pressure equals the saturated vapour pressure in: • degrees Celsius • degrees Fahrenheit
[°F]		
[kg/m <sup>3</sup> ]	Air density	Indicates the mass of air in proportion to a certain volume in: • kilograms per cubic metre • pounds per cubic foot
[lb/ft <sup>3</sup> ]		
[g/kg]	Saturation ratio	Indicates the relative mass ratio of ambient air saturated with humidity in the total mass in: • grams per kilogram • grains per pound • parts per million
[gr/lb]		
[ppm]		
[g/kg]	Mixing ratio	Indicates the mass of water vapour in proportion to the mass of dry gas in: • grams per kilogram • grains per pound • parts per million
[gr/lb]		
[ppm]		
[g/kg]	Mass fraction water vapour	Indicates the mass of water vapour in proportion to the mass of humid gas in: • grams per kilogram • grains per pound • parts per million
[gr/lb]		
[ppm]		
[ft <sup>3</sup> /h]	Norm volumetric flow	Converts the measured volumetric flow employing the ideal gas law to standard conditions (temperature and pressure). The following standard conditions can be set: • DIN 1343: 0 °C/1013,25 mbar • DIN ISO 2533: 25 °C/1013,25 mbar • DIN 1945-1: 20 °C/1013,25 mbar  The following units can be selected: • cubic feet per hour • cubic feet per minute • cubic feet per second • cubic inches per hour • cubic inches per minute • cubic inches per second • litres per minute • cubic metres per hour • cubic metres per minute • cubic metres per second
[ft <sup>3</sup> /min]		
[ft <sup>3</sup> /s]		
[in <sup>3</sup> /h]		
[in <sup>3</sup> /min]		
[in <sup>3</sup> /s]		
[l/min]		
[m <sup>3</sup> /h]		
[m <sup>3</sup> /min]		
[m <sup>3</sup> /s]		
[hPa]	Partial vapour pressure	Indicates the partial pressure of water in its gaseous phase in a given volume of a gas or gas mixture in: • hectopascal • pounds per square inch
[psi]		
[%]	Relative humidity	Indicates the relative humidity as the ratio of the partial water vapour pressure to the saturated vapour pressure under saturation conditions above water in per cent.

[Unit]	Measured value	Meaning
[%]	Relative humidity technical	Indicates the relative humidity as the ratio of the partial water vapour pressure to the saturated vapour pressure under saturation conditions above ice in per cent (only with temperatures below 0 °C).
[hPa]	Relative pressure	Indicates the air pressure corrected to sea level employing the international barometric height formula in: <ul style="list-style-type: none"> <li>• hectopascal</li> <li>• millimetres of mercury</li> <li>• pounds per square inch</li> </ul> <p>The conversion enables that air pressures can be compared with one another independent of the sea level.</p>
[mmHg]		
[psi]		
[hPa]	Saturation water vapour pressure above ice	Indicates the partial water vapour pressure under saturation conditions above ice in: <ul style="list-style-type: none"> <li>• hectopascal</li> <li>• pounds per square inch</li> </ul>
[psi]		
[hPa]	Saturation water vapour-pressure above water	Indicates the partial water vapour pressure under saturation conditions above water in: <ul style="list-style-type: none"> <li>• hectopascal</li> <li>• pounds per square inch</li> </ul>
[psi]		
[kJ/kg]	Specific enthalpy	Indicates the state variable of the humid gas, which is composed of the specific enthalpies of the mixture components and based on the mass fraction of the dry gas, in: <ul style="list-style-type: none"> <li>• British Thermal Unit per pound</li> <li>• Kilojoule per kilogram</li> </ul>
[BTU/lb]		
[m/s]	Flow speed	Indicates the movement of fluids or gases as proportion of length to a certain time in: <ul style="list-style-type: none"> <li>• feet per minute</li> <li>• metres per second</li> </ul>
[fpm]		
[°C]	Dew point-temperature	Indicates the temperature setting in during condensation when the current partial water vapour pressure equals the saturated vapour pressure in: <ul style="list-style-type: none"> <li>• degrees Celsius</li> <li>• degrees Fahrenheit</li> </ul>
[°F]		
[°C]	Temperature	Indicates the measured air temperature in: <ul style="list-style-type: none"> <li>• degrees Celsius</li> <li>• degrees Fahrenheit</li> </ul>
[°F]		
[%]	Volume fraction of water vapour	Indicates the volume fraction of water vapour in proportion to the total volume of humid gas in: <ul style="list-style-type: none"> <li>• per cent</li> <li>• parts per million</li> </ul>
[ppm]		
[ft <sup>3</sup> /h]	Flow rate	Indicates the volume calculated from the measured flow rate and the set area in: <ul style="list-style-type: none"> <li>• cubic feet per hour</li> <li>• cubic feet per minute</li> <li>• cubic feet per second</li> <li>• cubic inches per hour</li> <li>• cubic inches per minute</li> <li>• cubic inches per second</li> <li>• litres per minute</li> <li>• cubic metres per hour</li> <li>• cubic metres per minute</li> <li>• cubic metres per second</li> </ul>
[ft <sup>3</sup> /min]		
[ft <sup>3</sup> /s]		
[in <sup>3</sup> /h]		
[in <sup>3</sup> /min]		
[in <sup>3</sup> /s]		
[l/min]		
[m <sup>3</sup> /h]		
[m <sup>3</sup> /min]		
[m <sup>3</sup> /s]		
[aw]		
[ppm]	Water content (oil)	Displays the ratio of mass water to mass oil. Water content is a value calculated from water activity and oil temperature. Oil specific parameters are needed for the calculation.
[ppm]	CO <sub>2</sub> -concentration momentary	Displays the current CO <sub>2</sub> concentration in air. The measured value is updated every 15 seconds..
[ppm]	CO <sub>2</sub> -concentration averaged	Displays the CO <sub>2</sub> concentration in air. The measured value is the median of the last 11 measured values.

## 5.23 "Archive" screen

In the "Archive" screen, you can view archived measuring projects or open them for further processing:



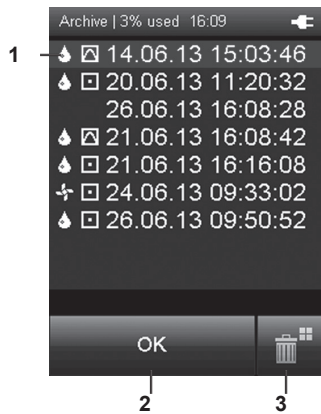

**Archive, fig. A.:**



- 1 Shows the measuring projects which are saved in the archive. The currently selected archive entry is highlighted
  1. Press the "Down" key on the cross control until the desired archive entry is selected.
  2. You may need to turn the page by pressing the "Left" or "Right" keys on the cross control.
  3. Press the "OK" key on the cross control to confirm the selected archive entry. You can also press "OK" (2) on the screen key. ⇒ Fig. B. opens.
- 2 Selects the currently selected archive entry. ⇒ Fig. B. opens.
- 3 Deletes all entries from the archive. ⇒ A safety prompt opens. Confirm it by pressing the "OK" key if you want to delete all entries. Otherwise, touch the "Cancel" key

The icons beside the saved measuring projects show each measuring mode (see examples in fig.A.).

The meaning is as follows:

-  Flowrate measurement
-  Measurement of humidity, temperature or air pressure
-  Spot measurement
-  Time measurement

**Archive, fig. B.:**



- 4 Opens the selected archive entry (see fig. C.).
- 5 Deletes the selected archive entry. ⇒ A safety prompt opens. Confirm it by pressing the "OK" key if you want to delete the entry. Otherwise, touch the "Cancel" key.
- 6 Closes fig. B. and returns to fig. A.

### Archive, fig. C.:

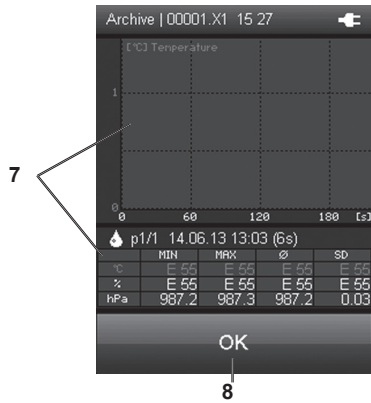

- Charts (top of fig. C.) and tabulates (bottom of fig. C.) the measured values.

You can select one of the three different measurement channels using the "Up" and "Down" keys on the cross control until. The selected measurement channel will be highlighted in the table.

Displayed in the table are the minimum value (MIN), the maximum value (MAX), the arithmetic average ( $\emptyset$ ) and the standard deviation (SD).

In case the data won't fit onto one table page after a longer recording session, you can browse through the timeline ([s], on the right in fig. C.) by using the "Left" and "Right" keys on the cross control unit.

- Closes the selected archive entry and returns to fig. A.

## 5.24 "Settings" screen

### Settings 1/3:



You can configure the device as follows in the "Settings" screen:

- Selects the screen language (see chapter "Set language").
- Selects the unit system:
  - Metric: Activates the metric unit system for all available measured values (e.g. for use in continental Europe).
  - Imperial: Activates the imperial unit system for all available measured values (e.g. for use in the USA).
- Sets the screen brightness. This option can only be selected by using the cross control below the colour display.
  - Press the "Down" key on the cross control until the scale is selected.
  - Press the "Left" or "Right" keys on the cross control to reduce (left) or increase (right) the screen brightness.
- Sets the date and time. This option can only be selected by using the cross control below the colour display.
  - Press the "Down" key on the cross control until the date is selected.
  - Press the "OK" key on the cross control.
    - ⇒ The entire row is selected
  - Press the "Left" or "Right" keys on the cross control to select the value to be configured.
  - Press the "Up" or "Down" keys on the cross control to increase or reduce the value to be configured.

### Settings 2/3:

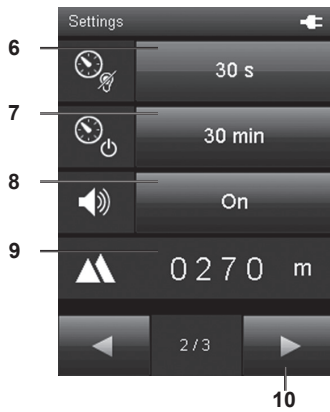

5. Press the "OK" key on the cross control.

⇒ The row is deselected.

5 Opens the next screen.

6 Either specifies the period for automatic dimming of the colour display or deactivates the function:  
30 seconds, 1 minute, 5 minutes, off

7 Either specifies the period for automatic switch-off of the colour display or deactivates the function:  
10 minutes, 30 minutes, 1 hour, off

#### Note!

This function is deactivated during an automatic measurement.

8 Switches signal tones/key tones on or off.

9 Sets the height above sea level (SL).

This value is i.a. required for the calculation of the relative air pressure and other values.

This option can only be selected by using the cross control below the colour display.

1. Press the "Down" key on the cross control until the numerical value is selected.

2. Press the "OK" key on the cross control.

⇒ The first number is selected.

3. Press the "Left" or "Right" keys on the cross control to select the number to be configured.

4. Press the "Up" or "Down" keys on the cross control to increase or reduce the value to be configured.

5. Press the "OK" key on the cross control.

⇒ The single number is deselected.

### Settings 3/3:

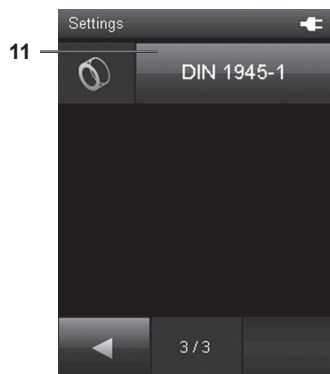

10 Opens the next screen.

11 Determines the setting for the amount of gas or the volumetric flow to be measured (also see chapter "Explanation of the measured values" page 28):  
DIN 1343, DIN ISO 2533, DIN 1945-1

#### Note!

Before using the multifunctional hand-held, make sure that you are aware of the device's intended purpose and the respective standard in effect as well as the contents of this standard.



## 5.25 Performing measurement (exemplary using probe for temperature and air flow measuring)

### Note:

Note that moving from a cold area to a warm area can lead to condensation forming on the device's circuit board. This physical and unavoidable effect can falsify the measurement. In this case, the colour display shows either no measured values or they are incorrect. Wait a few minutes until the device has become adjusted to the changed conditions before carrying out a measurement.

After connecting a probe, the multifunctional hand-held automatically selects the appropriate measuring mode. The corresponding screen is displayed and the measurement begins.

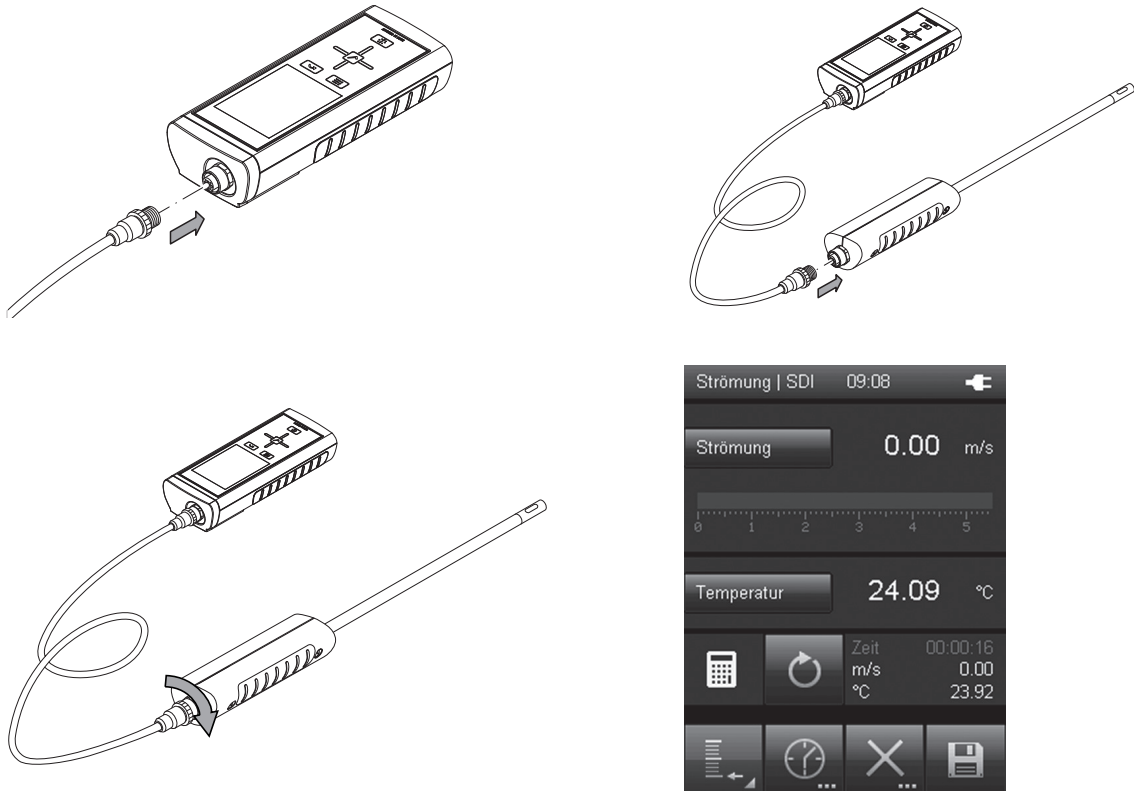

## 5.26 Shut down procedure

1. Switch off the device by pressing the "On/Off" key (see chapter "Switching off").
2. Detach connecting cables and sensors.
3. Clean the device according to the chapter "Maintenance".
4. Store the device according to the chapter "Storage".

## 6. PC-SOFTWARE

Use the SmartGraph3 PC software to carry out a detailed analysis and visualisation of your measured results. Only by employing this software can all options of the multifunctional hand-held for visualization and functioning be utilized (e.g. data export into an Excel/PDF file or data output in form of a printout).

You can open a basic display of your measured values at any time in the device (see chapter "Description of screen elements").

### 6.1 Installation conditions

Ensure that the following minimum requirements for installing the SmartGraph3 PC software are fulfilled:

- Supported operating systems (32 or 64 bit version):
  - Windows XP from service pack 3
  - Windows Vista
  - Windows 7
  - Windows 8
- Software requirements:
  - Microsoft .NET Framework (is automatically installed during the software installation, where applicable)
- Hardware requirements:
  - Processor speed: 1.6 GHz, minimum
  - USB connection
  - 2 GB RAM, minimum
  - 1 GB hard disk space, minimum

### 6.2 Installing the PC software

1. Download the current PC software from the Internet. To do so, visit the website [www.epluse.com/smartgraph3](http://www.epluse.com/smartgraph3).
2. Double-click the downloaded file.
3. Follow the instructions of the installation wizard.

### 6.3 Starting the PC software

1. Start the SmartGraph3 software.
2. Switch on the multifunctional hand-held (see chapter "Switching on") if necessary.
3. Connect the multifunctional hand-held to your PC via the USB connection cable provided in the scope of delivery. After a few seconds (up to one minute) the multifunctional hand-held is automatically detected and added to the device list in the SmartGraph3 software.

Information about using the PC software is provided in the online help.

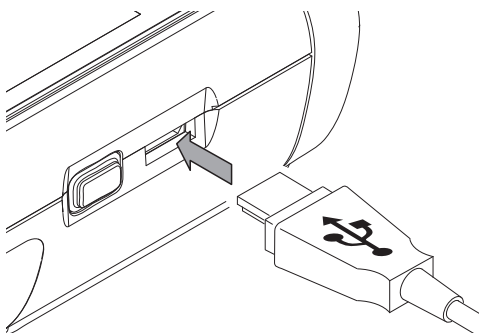

## 7. ERRORS AND FAULTS

The accurate functionality of the device was tested during production a number of times. However, if functionality faults do occur, then check the device according to the following list.

### The device does not switch on:

- Check the loading status of the batteries. Replace the batteries when the battery symbol in the colour display only shows one bar. If the battery symbol is red, then the battery voltage is insufficient.
- Check that the batteries are properly positioned. Check the polarity is correct.
- Never carry out an electrical check yourself

### The device is switched on, but no measured values are displayed:

- Check whether the multifunctional hand-held is in the correct probe mode.
- Check the connected connection cable for correct fit.
- Check the used connection cable and its connections as well as the connections to the multifunctional hand-held for damage (e.g. broken cable, damaged contacts etc.). Use a different connection cable of the same type to rule out possible faults.
- Ensure that the appropriate probe for the measurement is being used. Here, also consider the general catalogue or the product catalogue for measuring devices.
- Ensure that the colour display is switched on. Possibly use the "Illumination on/off" key (see chapter "Device depiction").
- Check the room temperature and the relative humidity. Check the device's permissible operating range complies with the technical data.
- Check whether the multifunctional hand-held responds to touching of the colour display. If it shows no reaction despite an enabled colour display and sufficient battery power, remove the batteries for approx. 1 minute. Subsequently refit the batteries (see chapter "Inserting the batteries") and restart the multifunctional hand-held.

### 7.1 Status and error codes

Status/error code	Meaning
E 27	Faulty factory setting
E 2C	Failed initialization of a component
E 50	Measured value above the specified range
E 51	Measured value below the specified range
E 52	Measured value physically supersaturated(upper limit)
E 53	Measured value physically supersaturated (lower limit)
E 54	Receipt of invalid data
E 55	Probe missing or defective
E FF	Unknown fault

## 8. MAINTENANCE

### 8.1 Maintenance and care intervals

Maintenance and care interval	before every start	when necessary	at least every 4 weeks	at least annually
check connections for digital sensors and micro USB for dirt and foreign objects and clean if necessary	X			
clean housing		X		X
visually check whether the device is dirty		X	X	
replace batteries		X		
check for damage	X			
carry out a test run				X

## 8.2 Activities for before the start of maintenance

1. Switch off the device (see chapter "Switching off").
2. Detach connecting cables and probes.

For maintenance or repair work which requires the housing to be opened, contact E+E customer service. Devices which have been opened unlawfully are void of any warranty and warranty claims.

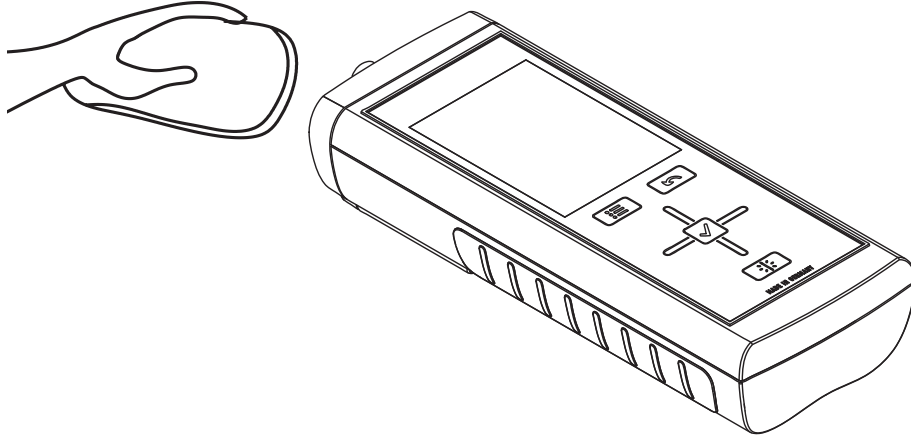

## 8.3 Visual inspection of the device

1. Check the device for dirt and possible damage.
2. Check the connection for digital probes and the micro USB connection for dirt and possible damage.
3. Check the colour display for dirt and possible damage.
4. Check that the batteries and battery cover sits properly.

Damaged connections can falsify measurements and measurement results.  
A damaged colour display can influence how measured results are shown.

## 8.4 Cleaning the device

1. Use a soft, lint-free cloth for cleaning.
2. Dampen the cloth with clean water. Do not use sprays, solvents, alcohol-based or abrasive cleaners to dampen the cloth.
3. Clear dirt from the housing, the connections and the colour display.

## 8.5 Maintenance of humidity probes

Instructions for proper cleaning and calibration of the humidity probes, can be found online at [www.epluse.com/omniport30](http://www.epluse.com/omniport30) in the section "Downloads".

## 9. DISPOSAL

In the European Union, electronic equipment must not be treated as domestic waste, but must be disposed of professionally in accordance with directive 2002/96/EC of the European Parliament and Council of 27th January 2003 concerning old electrical and electronic equipment. After the end of its use, please dispose of this device in a manner appropriate to the relevant legal requirements.

In the European Union, batteries must not be treated as domestic waste, but must be disposed of professionally in accordance with Directive 2006/66/EC of the European Parliament and Council of 6th September 2006 concerning batteries and accumulators. Please dispose of batteries in a manner appropriate to the relevant legal requirements.

## 10. DECLARATION OF CONFORMITY

in accordance with EC Low Voltage Directive 2006/95/EC and the EC Directive 2004/108/EC about electromagnetic compatibility. Herewith, we declare that the multifunctional hand-held Omniport 30 was developed, constructed and produced in compliance with the named EC directives.

Applied harmonised standards:

EN 61326-1:2006,

EN 61326-2-1:2006

IEC 61326-1:2005

IEC 61326-2-1:2005

The  marking is found on the rear of the device.





**HEAD OFFICE:**

**E+E ELEKTRONIK Ges.m.b.H.**

Langwiesen 7  
A-4209 Engerwitzdorf  
Austria  
Tel: +43 7235 605 0  
Fax: +43 7235 605 8  
info@epluse.com  
[www.epluse.com](http://www.epluse.com)

**SALES OFFICES:**

**E+E CHINA / BEIJING**

Tel: +86 10 84992361  
info@epluse.cn [www.epluse.cn](http://www.epluse.cn)

**E+E CHINA / SHANGHAI**

Tel: +86 21 61176129  
info@epluse.cn [www.epluse.cn](http://www.epluse.cn)

**E+E GERMANY**

Tel: +49 6172 13881 0  
info@epluse.de [www.epluse.de](http://www.epluse.de)

**E+E FRANCE**

Tel: +33 4 7472 35 82  
info@epluse.fr [www.epluse.fr](http://www.epluse.fr)

**E+E ITALY**

Tel: +39 02 2707 8636  
info@epluse.it [www.epluse.it](http://www.epluse.it)

**E+E KOREA**

Tel: +82 31 732 6050  
info@epluse.co.kr [www.epluse.co.kr](http://www.epluse.co.kr)

**E+E USA**

Tel: +1 508 530 3068  
office@epluse.com [www.epluse.com](http://www.epluse.com)